



深圳市海凌科电子有限公司 **Shenzhen Hi-Link Electronic Co.,Ltd**  
[Http://www.hlotech.com](http://www.hlotech.com) Tel:0755-83575155 Fax:0755-83575189



Shenzhen Hi-Link Electronic Technology co., Ltd

---

# HLK-RM04 User Manual

ETHERNET

WIFI

Full Function Serial Network/Wireless Module

|   |                         |   |
|---|-------------------------|---|
| 1 | BRIEF INTRODUCTION..... | 5 |
| 2 | SUMMARIZE.....          | 5 |

|            |  |           |
|------------|--|-----------|
| 2.1        | TECHNICAL SPECIFICATIONS .....                 | 5         |
| 2.2        | HARDWARE EXPLANATION .....                     | 6         |
| 2.2.1      | <i>Mechanical Dimensions</i> .....             | 6         |
| <b>3</b>   | <b>QUICK START</b> .....                       | <b>8</b>  |
| 3.1        | RESTORE FACTORY SETTINGS .....                 | 8         |
| 3.2        | CONFIGURATE NETWORK PARAMETER .....            | 8         |
| 3.3        | CONFIGURATE SERIAL NETWORK PARAMETER .....     | 9         |
| <b>4</b>   | <b>FUNCTION DESCRIPTION</b> .....              | <b>9</b>  |
| 4.1        | SERIAL TO ETHERNET.....                        | 9         |
| 4.2        | SERIAL TO WIFI CLIENT.....                     | 10        |
| 4.3        | SERIAL TO WIFI AP .....                        | 10        |
| 4.4        | DEFAULT MODE.....                              | 11        |
| 4.5        | SERIAL WORK MODE SWITCHING .....               | 11        |
| 4.6        | SERIAL-NET DATA CONVERSION .....               | 13        |
| <b>4.7</b> | <b>PARAMETER CONFIGURATION DIRECTION</b> ..... | <b>15</b> |
| <b>5</b>   | <b>WEB CONFIGURATION</b> .....                 | <b>15</b> |
| 5.1        | WEB NETWORK CONFIGURATION.....                 | 16        |
| 5.1.1      | <i>Serial to Ethernet-dynamic ip</i> .....     | 17        |
| 5.1.2      | <i>Serial to Ethernet-static ip</i> .....      | 17        |
| 5.1.3      | <i>Serial to WIFI CLIENT-dynamic ip</i> .....  | 17        |
| 5.1.4      | <i>Serial to WIFI CLIENT-static ip</i> .....   | 18        |
| 5.1.5      | <i>Serial to WIFI AP</i> .....                 | 18        |
| 5.2        | WEB SERIAL CONFIGURATION .....                 | 18        |
| 5.3        | SUBMITTING ALTERATION .....                    | 20        |
| <b>6</b>   | <b>SERIAL AT COMMAND CONFIGURATION</b> .....   | <b>20</b> |
| 6.1        | ACCESS TO AT COMMAND MODE.....                 | 20        |
| 6.2        | AT COMMAND .....                               | 20        |
| 6.2.1      | <i>Net mode</i> .....                          | 21        |
| 6.2.2      | <i>wifi_conf</i> .....                         | 22        |
| 6.2.3      | <i>Channel</i> .....                           | 22        |
| 6.2.4      | <i>dhcpc</i> .....                             | 22        |
| 6.2.5      | <i>net_ip</i> .....                            | 23        |

|          |  |           |
|----------|--|-----------|
| 6.2.6    | <i>net_dns</i> .....                                   | 23        |
| 6.2.7    | <i>dhcpd</i> .....                                     | 23        |
| 6.2.8    | <i>dhcpd_ip</i> .....                                  | 24        |
| 6.2.9    | <i>dhcpd_dns</i> .....                                 | 24        |
| 6.2.10   | <i>dhcpd_time</i> .....                                | 24        |
| 6.2.11   | <i>net_commit</i> .....                                | 25        |
| 6.2.12   | <i>out_trans</i> .....                                 | 25        |
| 6.2.13   | <i>remoteip</i> .....                                  | 25        |
| 6.2.14   | <i>remoteport</i> .....                                | 26        |
| 6.2.15   | <i>remotepro</i> .....                                 | 26        |
| 6.2.16   | <i>timeout</i> .....                                   | 26        |
| 6.2.17   | <i>mode</i> .....                                      | 26        |
| 6.2.18   | <i>uart</i> .....                                      | 27        |
| 6.2.19   | <i>uartpacklen</i> .....                               | 27        |
| 6.2.20   | <i>uartpacktimeout</i> .....                           | 27        |
| 6.2.21   | <i>escape</i> .....                                    | 27        |
| 6.2.22   | <i>tcp_auto</i> .....                                  | 28        |
| 6.2.23   | <i>save</i> .....                                      | 28        |
| 6.2.24   | <i>reconn</i> .....                                    | 28        |
| 6.2.25   | <i>ver</i> .....                                       | 29        |
| 6.3      | AT COMMAND CONTROL CODE ROUTION .....                  | 29        |
| 6.3.1    | <i>Inquiry configuration information</i> .....         | 29        |
| 6.3.2    | <i>Serial to Ethernet(Dynamic ip address)</i> .....    | 30        |
| 6.3.3    | <i>Serial to Ethernet(static ip address)</i> .....     | 31        |
| 6.3.4    | <i>Serial to wifi client(dynamic IP address)</i> ..... | 32        |
| 6.3.5    | <i>Serial to wifi client(static IP address)</i> .....  | 32        |
| 6.3.6    | <i>Serial to wifi AP</i> .....                         | 33        |
| 6.3.7    | <i>Restore factory value</i> .....                     | 34        |
| <b>7</b> | <b>SERIAL CONFIGURATION TOOLS</b> .....                | <b>35</b> |
| 7.1      | SEARCHING THE MODULE.....                              | 37        |
| 7.2      | SET EACH PARAMETERS.....                               | 37        |
| 7.3      | SUBMIT THE CONFIGURATION.....                          | 38        |
| 7.4      | USER DATA RETENTION .....                              | 39        |
| 7.5      | INQUIRY CONFIGURATION .....                            | 39        |



|           |   |           |
|-----------|---|-----------|
| 7.6       | ACCESS TO TRANSPARENT TRANSMISSION MODE.....    | 39        |
| 7.7       | RESTORE FACTORY FACTORY VALUE SETTING.....      | 39        |
| <b>8</b>  | <b>DEVICE SEARCH TOOLS.....</b>                 | <b>40</b> |
| <b>9</b>  | <b>RESTORE FACTORY SETTINGS.....</b>            | <b>41</b> |
| <b>10</b> | <b>FIRMWARE UPGRADE.....</b>                    | <b>42</b> |
|           | <b>APPENDIX A DOCUMENT REVISION RECORD.....</b> | <b>42</b> |

## 1 Brief Introduction

HLK-RM04 is a new low-cost embedded UART-ETH-WIFI module (serial port - Ethernet - Wireless network) developed by Shenzhen Hi-Link ElectronicTechnology co., Ltd

This product is an embedded module based on the universal serial interface network standard, built-in TCP / IP protocol stack, enabling the user serial port, Ethernet, wireless network (wifi) interface between the conversions.

Through the HLK-RM04 module, the traditional serial devices do not need to change any configuration; data can be transmitted through the Internet network. Provide a quick solution for the user's serial devices to transfer data via Ethernet.

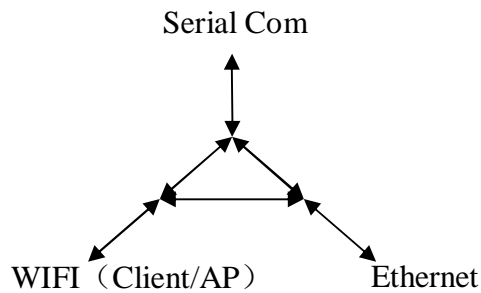

Picture1.F-structure

## 2 Summarize

### 2.1 Technical Specifications

Table2-1 Technical Specifications

|                            |  |
|----------------------------|--|
| Network standard           | wireless: IEEE 802.11n、IEEE 802.11g、IEEE 802.11b |
|                            | wired: IEEE 802.3、IEEE 802.3u                    |
| Wireless transmission rate | 11n: maximum up to 150Mbps                       |
|                            | 11g: maximum up to 54Mbps                        |
|                            | 11b: maximum up to 11Mbps                        |
| Tracks number              | 1-14   |
| Frequency range            | 2.4-2.4835G                                      |
| Emission power             | 12-15DBM   |
| Interface                  | 2 Ethernet,2 serial,1 usb (host/slave) ,GPIO     |
| <b>Antenna</b>             |  |
| Antenna type               | Onboard antenna / External Antenna               |

|                              |  |
|------------------------------|--|
| <b>Functional Parameters</b> |  |
| WIFI work mode               | Client/AP/Router                                     |
| WDS Function                 | Support WDS wireless bridge connection               |
| Wireless security            | Wireless MAC address filtering                       |
|                              | <b>Wireless security function switch</b>             |
|                              | 64/128/152 bit WEP encryption                        |
|                              | WPA-PSK/WPA2-PSK、WPA/WPA2 security mechanism         |
| Network management           | Remote Web management                                |
|                              | <b>Configuration file import and export</b>          |
|                              | WEB software upgrade                                 |
| <b>Serial to Ethernet</b>    |  |
| Maximum transmission rate    | 230400bps  |
| TCP connection               | Max connection number>20                             |
| UDP connection               | Max connection number>20                             |
| Serial baud rate             | 50~230400bps   |
| <b>Other Parameters</b>      |  |
| Status indicator             | Status indicator                                     |
| Environmental standard       | Operating temperature: -20-70℃                       |
|                              | Operating humidity: 10%-90%RH (noncondensing)        |
|                              | Storage temperature: -40-80℃                         |
|                              | Storage humidity: 5%-90%RH (noncondensing)           |
| Additional properties        | Frequency bandwidth optional: 20MHz、40MHz, Automatic |

## 2.2 Hardware Explanation

### 2.2.1 Mechanical Dimensions

HLK-RM04 *Mechanical* Dimensions is shown in the following picture:

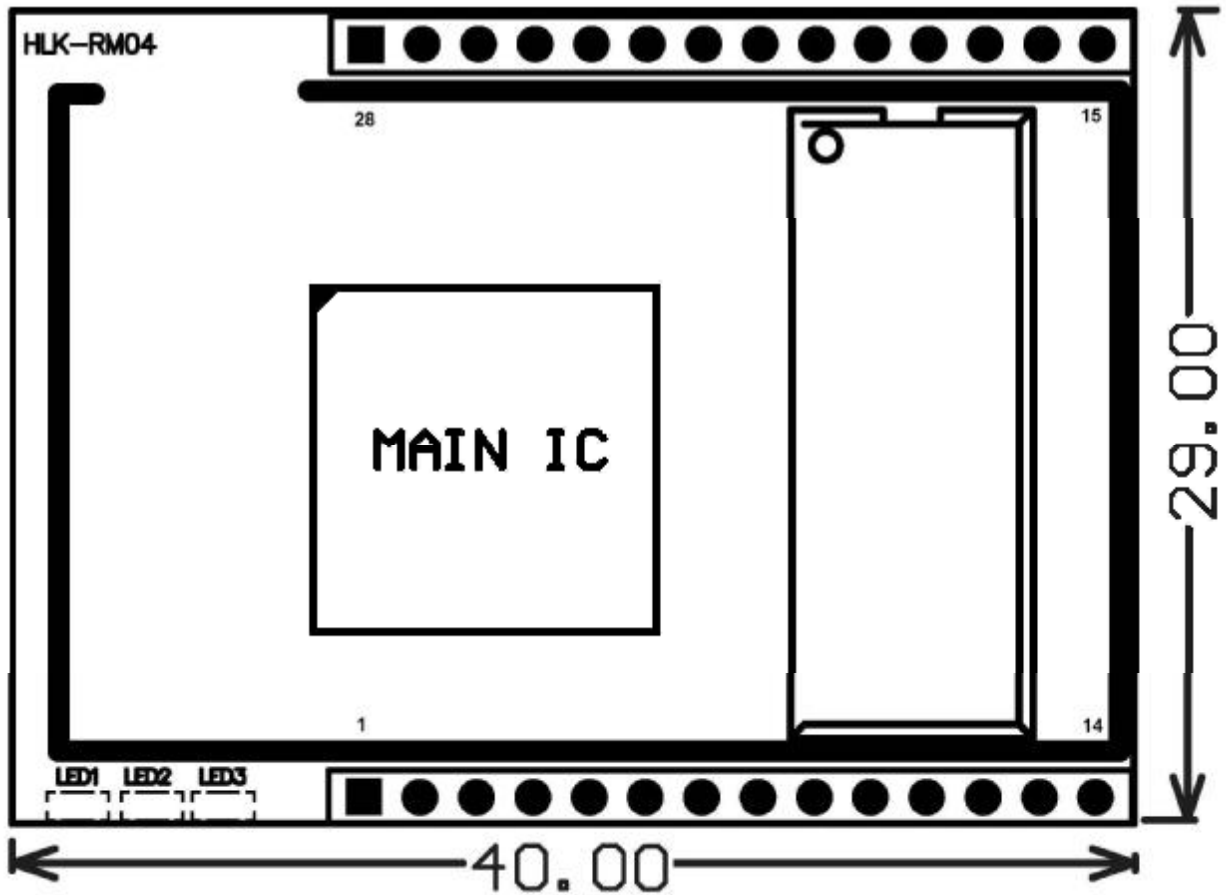

Picture2.Dimensions Unit:mm

### 2.2.2 Pins Interface

The Pin of this product as shown above is defined as follows:

Table2-2 module pin interface

| No. | Function   | Direction | Explanation  |
|-----|------------|-----------|--|
| 1   | VCC        | Power In  | 5V power input   |
| 2   | GND        | GND       | Power ground   |
| 3   | WLAN_LED   | O         | WIFI starting instruction  |
| 4   | VDD        | Power Out | 3.3V Power output  |
| 5   | LINK2      | O         | Net gape 2 connection indicating                                 |
| 6   | USB_P      | I/O       | USB signal+  |
| 7   | USB_M      | I/O       | USB signal-  |
| 8   | STA/GPIO_0 | I/O       | Status indicating/GPIO_0   |
| 9   | GPIO_1     | I/O       | GPIO_1   |
| 10  | ES/RST     | I         | Exit transparent transmission mode/restore factory value setting |

|    |              |           |                                  |
|----|--------------|-----------|----------------------------------|
| 11 | TXOP2        | A         | Net gape 2 TX-P                  |
| 12 | TXON2        | A         | Net gape 2 TX-N                  |
| 13 | RXIP1        | A         | Net gape 1 RX-P                  |
| 14 | RXIN1        | A         | Net gape 1 RX-N                  |
| 15 | RXIN2        | A         | Net gape 2 RX-P                  |
| 16 | RXIP2        | A         | Net gape 2 RX-P                  |
| 17 | TXON1        | A         | Net gape 1 TX-N                  |
| 18 | TXOP1        | A         | Net gape 1 TX-P                  |
| 19 | RTS_N/GPIO_2 | I/O       | Serial 2 RTS                     |
| 20 | UART_RX      | I         | Serial 1 RX                      |
| 21 | UART_TX      | O         | Serial 1 TX                      |
| 22 | RXD/GPIO_3   | I/O       | Serial 2 RX                      |
| 23 | LINK1        | I/O       | Serial 1 connection indicating   |
| 24 | CTS_N/GPIO_4 | O         | Serial 2 CTS                     |
| 25 | WPS/RST      | I         | WPS button/restore factory value |
| 26 | TXD/GPIO_5   | O         | Serial 2 TX                      |
| 27 | VDD_1_8      | Power Out | Net gape 1.8V output             |
| 28 | VCC          | Power In  | 5V input                         |

Notes: The I/O port level voltage is 3.3 V

### 3 Quick Start

#### 3.1 Restore factory settings

In order to ensure that all of the configuration process is correct, bring the module to restore the factory settings first. If it is already in factory mode, you can skip this step. Power on the module with 5V (350mA) electric source, wait about 30 seconds, After starting, Lower ES/RST pin more than Trst, release of ES/RST feet, the system will automatically restart. After rebooting the system the module is already in Factory mode.

#### 3.2 Configure network parameter

Set the PC to static IP mode and then connect it with the module via Ethernet or wifi. The IP address is set to 192.168.16.100/255.255.255.0, gateway 192.168.16.254. The (wifi default ssid and



the default password, see this document.) open the browser <http://192.168.16.254>, enter the web configuration page, default user name and password is admin / admin. Modify the network parameters through the web. Now, the module's IP address is 192.168.16.254. Configuration details can be seen in 5.1.

### 3.3 Configure serial network parameter

Opens the browser <http://192.168.16.254/ser2net.asp>, enter the serial-to-network web configuration page. Configure the serial-to-network parameters as needed through a web page. Configuration details can be seen in 5.2.

## 4 Function Description

The module can be divided into four major modes: default mode, serial to Ethernet, serial to WIFI CLIENT and serial to WIFI AP.

### 4.1 Serial to Ethernet

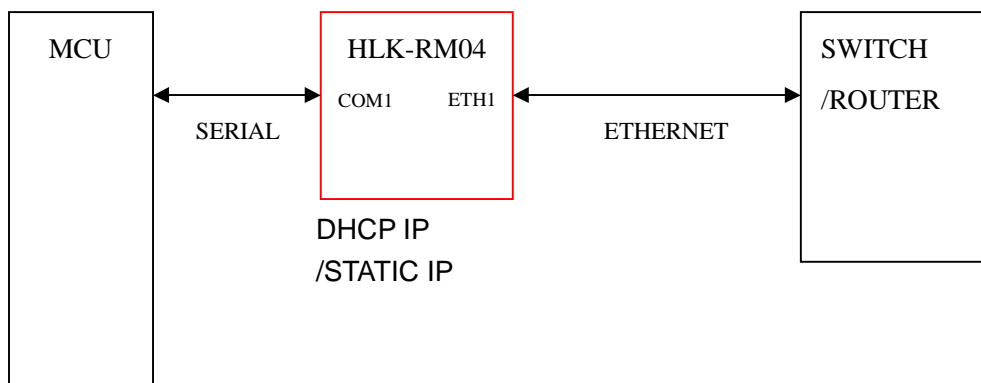

Chart3.serial to Ethernet model

In this mode, ETH1 enable, WIFI, ETH2 function close. Through the appropriate settings, the data between COM1 and ETH1 network can achieve mutual conversion.

Ethernet can be configured as dynamic IP address (DHCP), can also be configured as static IP address (STATIC).

## 4.2 Serial to WIFI CLIENT

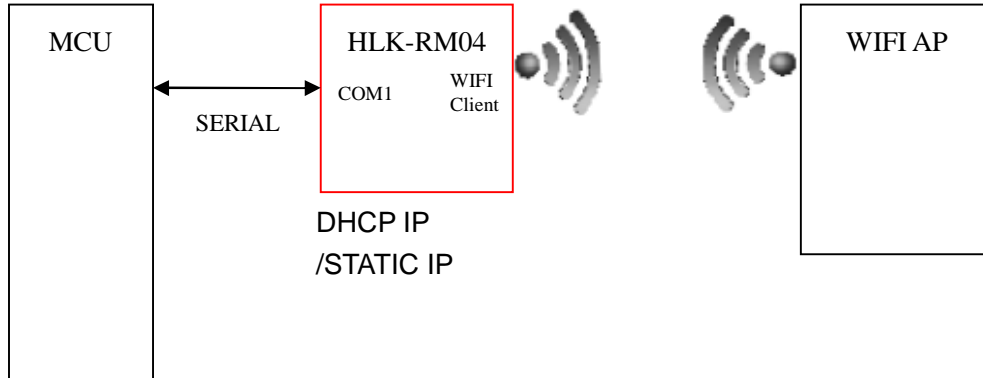

Chart 4.Serial to WIFI CLIENT model

In this mode, WIFI enable, module works in the client mode, ETH1, ETH2 function close. Through the appropriate settings, the data between COM1 and WIFI network can achieve mutual conversion.

WIFI CLIENT can be configured as dynamic IP address (DHCP), can also be configured as static IP address (STATIC).

WIFI safety: support all encryption methods at present.

## 4.3 Serial to WIFI AP

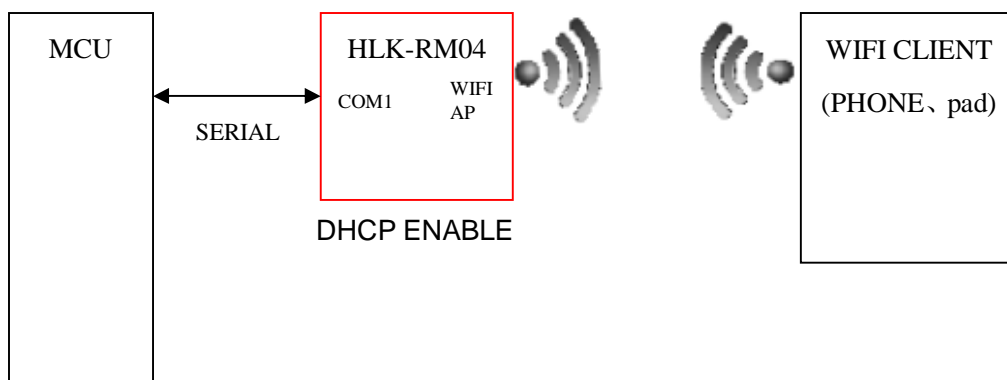

Chart 5. Serial to WIFI AP model

In this mode, WIFI enable, module works in the AP mode, ETH1, ETH2 function close.

Through the appropriate settings, the data between COM1 and WIFI network can achieve mutual conversion.

WIFI safety: support all encryption methods at present.

In this mode, WIFI device can connect with the module and become the device under WIFI LAN.

#### 4.4 Default mode

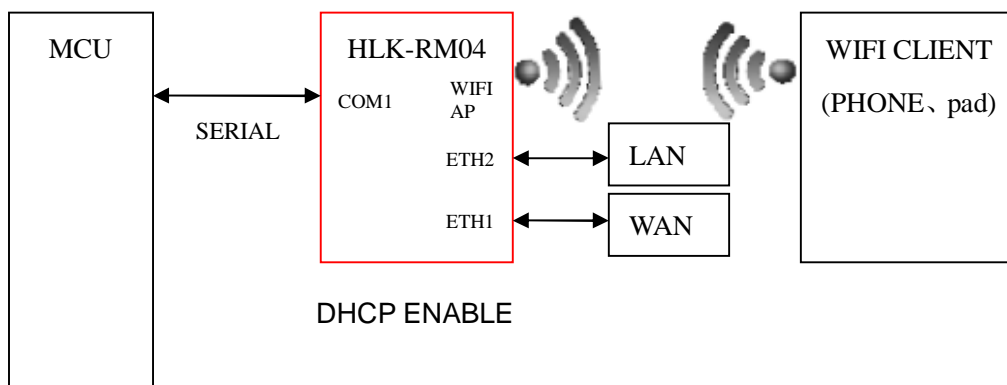

Chart 6.Default mode model

In this mode, WIFI enable, module works in the AP mode, ETH1, ETH2 function enable. ETH1 works as WAN, ETH2 works as LAN. Through the appropriate settings, the data between COM1 and network can achieve mutual conversion.

WIFI safety: support all encryption methods at present.

In this mode, WIFI device can connect with the module and become the device under WIFI LAN.

WAN default IP is dynamic IP address. LAN, WIFI for the same local area network, enabled by default DHCP server.

#### 4.5 Serial work mode switching

Module serial work status is defined as two modes: transparent transmission mode, the AT command mode

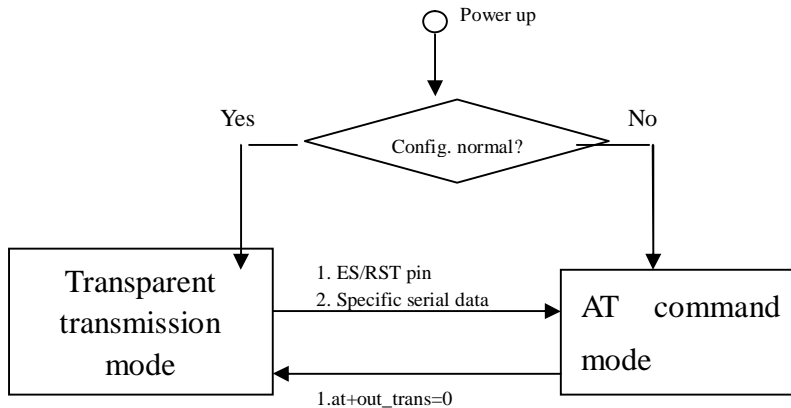

Chart 7.Serial work mode switching

After power-on normally, the module will check whether the current network serial port configuration is normal, if the network connection is normal, the module automatically enters transparent transmission mode, and otherwise the module will enter AT command mode.

There are two kinds of methods for transparent mode entering AT command mode:

1. ES/RST pin

In any state, to maintain the time of ES / RST pin' low level greater than  $T_{es}$  and less than  $T_{rst}$ , the module will immediately enter the AT command mode.

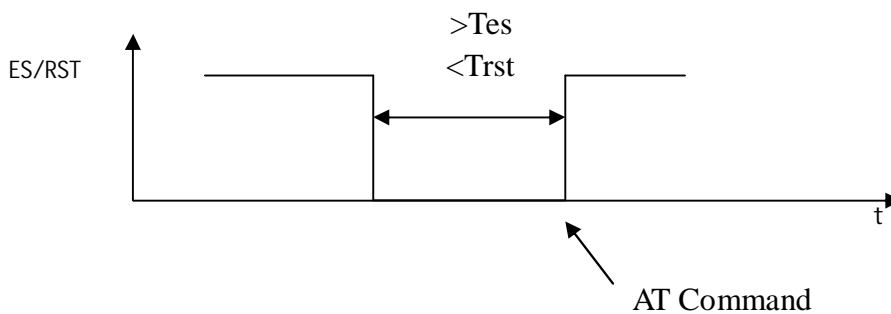

Chart 8. ES/RST Exit transparent transmission mode

2. Specific serial data

When serial exit pass-through feature is turned on, you can send specific serial data to make the module exit transparent transmission mode. Serial exit pass-through process is as follows:

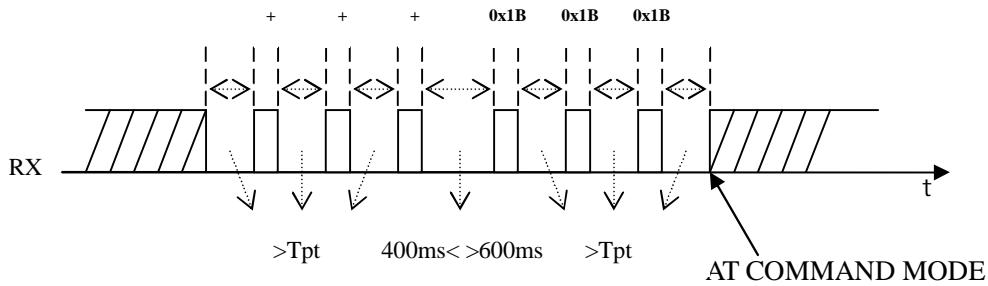

Chart 9. Serial exit transparent transmission mode

Notes:

Tpt: Serial framing time

The group frame time interval is greater than continuous send "+", and then wait for about 500ms (400ms < > 600ms) framing interval is greater than the time to send three consecutive 0x1B. The modules will exit the transparent transmission mode.

Notes: This function only can be used in the case of serial exit pass-through feature is turned on.

#### 4.6 Serial-net data conversion

There are four mode for serial-net conversion: TCP Server、TCP Client、UDP Server、UDP Client。

##### TCP Server

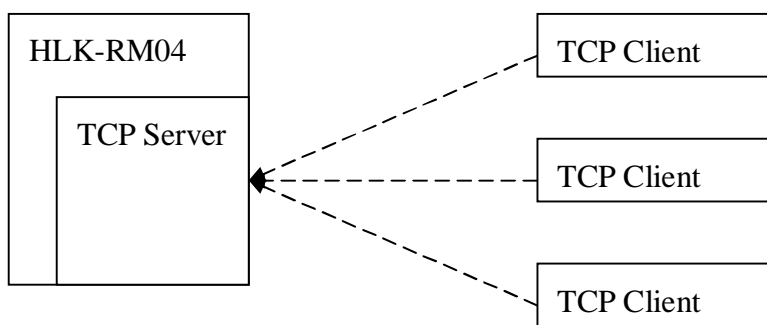

Chart 10. TCP Server

In this mode, the module is listening on the specified port, waiting for TCP Client connection, if connected, all TCP data is sent directly to the serial port end, the data of the serial end sent to TCP Client end

## TCP Client

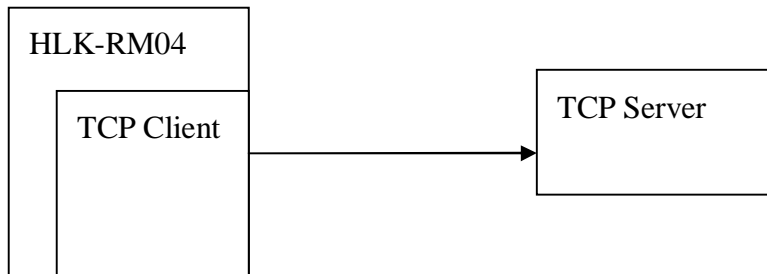

Chart 11.TCP Client

In this mode, the module is connected to the specified domain / IP port. All the data sent from the TCP Server-side end will be sent directly to the serial port, the data from the serial end sent to the TCP Server-side. Abnormal network disconnect will cause the module active reconnect. TCP Active reconnection function enable, TCP Server initiative disconnected, the module will immediately take the initiative to reconnect, and otherwise the module will not reconnect.

## UDP Server

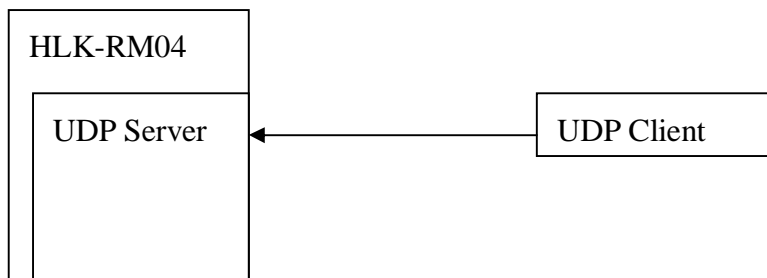

Chart 12.UDP Server

In this mode, the module opens the local designated port, once received the data sent to the port, the module will send the data to the serial port, and record the remote ip, port. The module will record only the last information on the remote connection. Serial received data will be sent directly to the recorded remote ip, port.

## UDP Client

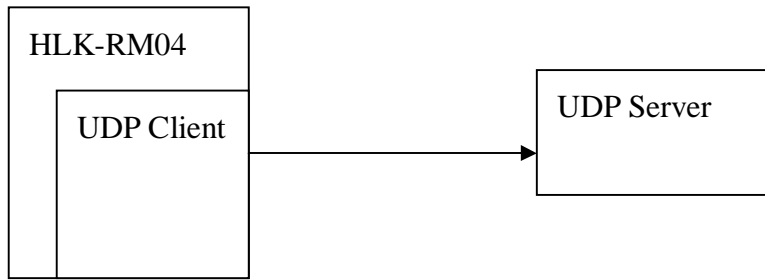

Chart 13.UDP Client

In this mode, the module directly sends the serial data to the specified ip, port. The serial data returned from the server-side will be distributed to serial port.

#### 4.7 Parameter configuration direction

The module provides two ways for the configuration parameters:

- 1.Web page;
2. Serial AT command.

Access to WEB configuration page requires the confirmation of the module's IP addresses, as well as the user name and password that authenticated by WEB.

Configuring parameters through the serial port AT command needs to make the module into the AT command mode first.

Serial configuration tool `HLK-RM04_CONFIG`: Configure the module through AT command, provide a easier and convenient configuration process through the configuration combination of each parameter.

#### 5 WEB configuration

**HLK-RM04 Serial2Net Settings**

NetMode:

---

|                            | Current         | Updated  |
|----------------------------|-----------------|--|
| Serial Configure:          | 115200,8,n,1    | <input type="text" value="115200,8,n,1"/>                              |
| Serial Framing Lenth:      | 64              | <input type="text" value="64"/>  |
| Serial Framing Timeout:    | 10 milliseconds | <input type="text" value="10"/> milliseconds (< 256, 0 for no timeout) |
| Network Mode:              | none            | <input type="text" value="None"/>                                      |
| Remote Server Domain/IP:   | 192.168.11.245  | <input type="text" value="192.168.11.245"/>                            |
| Locale/Remote Port Number: | 8080            | <input type="text" value="8080"/>                                      |
| Network Protocol:          | tcp             | <input type="text" value="TCP"/>                                       |
| Network Timeout:           | 0 seconds       | <input type="text" value="0"/> seconds (< 256, 0 for no timeout)       |

Chart 7.WEB configuration page

Through the correct module address (default address:<http://192.168.16.254/ser2net.asp>),you can access to the WEB configuration page.

The page can be divided into 3 areas:

- 1 Network configuration area
- 2 Serial function configuration areas
- 3 Configuration submit area

### 5.1 WEB network configuration

**Net mode selection:**

- Default – default work mode
- ETH-SERIAL – Serial to Ethernet
- WIFI (CLIENT)-SERIAL – serial to WIFI CLIENT
- WIFI (AP)-SERIAL) – Serial to WIFI AP

Choose different work mode, the web will show you different page.Mode configuration page is as follows:



### 5.1.1 Serial to Ethernet-dynamic ip

|          |   |
|----------|---|
| NetMode: | <input type="text" value="ETH-SERIAL"/> |
| IP Type: | <input type="text" value="DHCP"/>       |

Chart 8. Serial to Ethernet-dynamic

### 5.1.2 Serial to Ethernet-static ip

|                       |   |
|-----------------------|---|
| NetMode:              | <input type="text" value="ETH-SERIAL"/>     |
| IP Type:              | <input type="text" value="STATIC"/>         |
| IP Address:           | <input type="text" value="192.168.11.254"/> |
| Subnet Mask:          | <input type="text" value="255.255.255.0"/>  |
| Default Gateway:      | <input type="text" value="192.168.11.1"/>   |
| Primary DNS Server:   | <input type="text" value="192.168.11.1"/>   |
| Secondary DNS Server: | <input type="text" value="8.8.8.8"/>        |

Chart 9. Serial to Ethernet-static

### 5.1.3 Serial to WIFI CLIENT-dynamic ip

|               |  |
|---------------|--|
| NetMode:      | <input type="text" value="WIFI(CLIENT)-SERIAL"/> |
| SSID:         | <input type="text" value="Hi-Link_"/>            |
| Encrypt Type: | <input type="text" value="WPA2 AES"/>            |
| Password:     | <input type="text" value="12345678"/>            |
| IP Type:      | <input type="text" value="DHCP"/>                |

Chart 10. serial to WIFI CLIENT dynamic

#### 5.1.4 Serial to WIFI CLIENT-static ip

|                       |                     |
|-----------------------|---------------------|
| NetMode:              | WIFI(CLIENT)-SERIAL |
| SSID:                 | Hi-Link_            |
| Encrypt Type:         | WPA2 AES            |
| Password:             | 12345678            |
| IP Type:              | STATIC              |
| IP Address:           | 192.168.11.254      |
| Subnet Mask:          | 255.255.255.0       |
| Default Gateway:      | 192.168.11.1        |
| Primary DNS Server:   | 192.168.11.1        |
| Secondary DNS Server: | 8.8.8.8             |

Chart 11. Serial to WIFI CLIENT-static

#### 5.1.5 Serial to WIFI AP

|               |                 |
|---------------|-----------------|
| NetMode:      | WIFI(AP)-SERIAL |
| SSID:         | Hi-Link_        |
| Encrypt Type: | WPA2 AES        |
| Password:     | 12345678        |
| IP Address:   | 192.168.11.254  |
| Subnet Mask:  | 255.255.255.0   |

Chart12. Serial to WIFI AP

#### 5.2 WEB serial configuration

Serial Web configuration page (ser2net.asp) is as follows:

## Serial Settings

|                            | Current         | Updated  |
|----------------------------|-----------------|--|
| Serial Configure:          | 115200,8,n,1    | <input type="text" value="115200,8,n,1"/>                              |
| Serial Framing Lenth:      | 64              | <input type="text" value="64"/>  |
| Serial Framing Timeout:    | 10 milliseconds | <input type="text" value="10"/> milliseconds (< 256, 0 for no timeout) |
| Network Mode:              | client          | <input type="text" value="Client"/>                                    |
| Remote Server Domain/IP:   | 192.168.11.245  | <input type="text" value="192.168.11.245"/>                            |
| Locale/Remote Port Number: | 8080            | <input type="text" value="8080"/>                                      |
| Network Protocol:          | udp             | <input type="text" value="UDP"/>                                       |
| Network Timeout:           | 0 seconds       | <input type="text" value="0"/> seconds (< 256, 0 for no timeout)       |
|                            |                 | <input type="button" value="Submit"/>                                  |

**Current** shows the current configuration , **Updated** shows the current revision parameters。  
**Submit** submit the revision.

**Serial Configure:** Serial configuration.fomat: Baud rate, data bits, parity bit, stop bit.  
For example: “115200,8,n,1”.

**Serial Framing Lenth:** The Lenth of Serial Framing

**Serial Framing Timeout:** The time of Serial Framing

**Network Mode:** choose Client、Server or none。

**Remote Server Domain/IP:** Remote Server Domain/IP address

For expmale: 192.168.11.245 or [www.hlktech.com](http://www.hlktech.com) .

**Locale/Remote Port Number:** The specified parameter is not the same under the different network modes. Client specifies the port number on the remote, Server specified local port number.

**Network Protocol:** Use tcp or udp Protocol

**Network Timeout:** Under the server network mode, no data transmission within the timeout period, the connection will be disconnected. 0 specifies never disconnected.

### 5.3 Submitting Alteration

Click the button 'Apply' to submit the configuration of the current page. If some parameters of the network have changed, the submission process may take about 25 seconds. If you only modify the serial functional configuration, the submission process will be completed soon.

Click the button 'Cancel' to reload the page, the modified configuration will be lost.

## 6 Serial AT command configuration

### 6.1 Access to AT command mode

Module in network fault, such as fault allocation situation will automatically exit the transparent transmission mode, enter AT instruction mode. In any condition, keep ES/RST feet low level of time but more than  $T_{es}$  and less than  $T_{rst}$ , the module will enter AT instruction mode immediately.

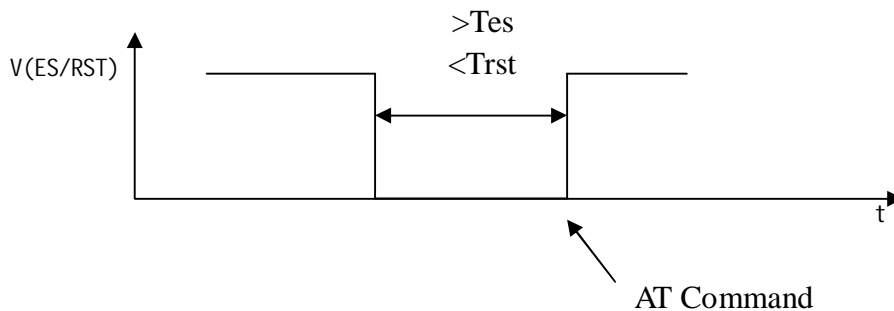

### 6.2 AT Command

In AT mode, you can configure the system parameters through the serial port AT instruction.

Instruction format is as follows:

At+[command]=[value]\r

According to the different command, module will return a different return value.

For example: "at+remoteip=192.168.11.133\n" set remote ip address as 192.168.11.133.

For example: "at+remoteip=? \n" Inquiry remote ip address.

At command is as follows:

|                        |  |
|------------------------|--|
| <b>netmode</b>         | Network mode                             |
| <b>wifi_conf</b>       | Wifi configuration                       |
| <b>dhcpc</b>           | Dhcp client configuration                |
| <b>net_ip</b>          | Network ip address                       |
| <b>net_dns</b>         | Network dns address                      |
| <b>dhcpd</b>           | Dhcp server configuration                |
| <b>dhcpd_ip</b>        | Dhcp server ip address                   |
| <b>dhcpd_dns</b>       | Dhcp server dns address                  |
| <b>dhcpd_time</b>      | Dhcp sever time allocation               |
| <b>net_commit</b>      | Submit network configuration             |
| <b>out_trans</b>       | Exit transparent transmission mode       |
| <b>remoteip</b>        | Remote server domain name or IP address  |
| <b>remoteport</b>      | The local or distal port number          |
| <b>remotepro</b>       | Network Protocol type                    |
| <b>timeout</b>         | Network timeout                          |
| <b>mode</b>            | Network mode                             |
| <b>uart</b>            | Serial port configuration                |
| <b>uartpacklen</b>     | Serial group frame length                |
| <b>uartpacktimeout</b> | Serial framing time                      |
| <b>save</b>            | Save the configuration and start service |
| <b>reconn</b>          | Restart services                         |
| <b>default</b>         | Restore factory value settings           |
| <b>reboot</b>          | Restart the module                       |
| <b>ver</b>             | The version of module                    |

### 6.2.1 Net mode

**Function:**

Network mode setting

**Format:**

At+netmode=<netmode>\r

**Parameters:**

Table 6-3 network mode

| value | meaning       |
|-------|---------------|
| 0     | Default setup |
| 1     | Ethernet      |

|   |             |
|---|-------------|
| 2 | Wifi client |
| 3 | Wifi ap     |

### 6.2.2 wifi\_conf

**Function:**

Wireless parameter setting

**Format:**

At+wifi\_conf=<ssid>, <encrypt type>, <password> \r

**Parameters:**

ssid: Network SSID

Encrypt type: Encryption mode

Table 6-4 Encryption mode

| value        | meaning                                    |
|--------------|--|
| none         | Open network                               |
| wep_open     | Wep encryption, open authentication method |
| wep          | Wep encryption, encryption authentication  |
| wpa_tkip     | wpa tkip                                   |
| wpa_aes      | wpa aes                                    |
| wpa2_tkip    | wpa2 tkip                                  |
| wpa2_aes     | wpa2 aes                                   |
| wpawpa2_tkip | wpa/wpa2 tkip                              |
| wpawpa2_aes  | wpa/wpa2 aes                               |

### 6.2.3 Channel

**Function:**

Wi Fi wireless channel select

**Format:**

At+Channel =<Channel >\r

**Parameter:**

Channel : 0-14

### 6.2.4 dhcp

**Function:**

Dhcp client enable

**Format:**

At+dhcpc=<dhcpc>\r

**Parameters:**

Table 6-5 Dhcp client enable

| value | meaning            |
|-------|--------------------|
| 0     | Static ip address  |
| 1     | Dynamic ip address |

## 6.2.5 net\_ip

**Function:**

Network mode setting

This parameter is not valid when Dhcp client feature is turned on.

**Format:**

At+Net\_ip=<ip>, <mask>, <gateway>\r

**Parameters:**

Ip: Ip address

Mask: Subnet mask

Gateway: Gateway Network Element

## 6.2.6 net\_dns

**Function:**

Network mode setting

This parameter is not valid when Dhcp client feature is turned on

**Format:**

At+Net\_dns=<dns1>, <dns2>\r

**parameters:**

dns1: Major DNS address

dns2: Minor DNS address

## 6.2.7 dhcpd

**Function:**

Dhcp server enable

This parameter is not valid when the network mode is AP.

**Format:**

At+dhcpcd=<dhcpcd>\r

**Parameters:**

Table 6-6 Dhcp servers enable

| value | meaning |
|-------|---------|
| 0     | close   |
| 1     | open    |

## 6.2.8 dhcpcd\_ip

**Function:**

Dhcp server IP setting

**Format:**

At+Dhcpcd\_ip=<ip start>, <ip end>, <mask>, <gateway>\r

**parameters:**

Ip start: Ip started address

Ip end: Ip ended address

Mask: Subnet mask

Gateway: Gateway Network Element

## 6.2.9 dhcpcd\_dns

**Function:**

Dhcp server dns setting

**Format:**

At+Dhcpcd\_dns=<dns1>, <dns2>\r

**Parameters:**

dns1: Major dns address

dns2: Minor dns address

## 6.2.10 dhcpcd\_time

**Function:**

Dhcp server time setting

**Format:**

At+Dhcpcd\_time=<time >\r

**Parameters:**

time: Dhcp effective time assigned to device.



## 6.2.11 net\_commit

**Function:**

Submit to network setting

Network configuration parameters set to be submitted by this parameter to save the entry into force.

**Format:**

At+Net\_commit=<Net\_commit >\r

**Parameters:**

Table 6-7 submit to network setting

| value | meaning |
|-------|---------|
| 0     | invalid |
| 1     | submit  |

## 6.2.12 out\_trans

**Function:**

Exit the transparent transmission mode

**Format:**

At+out\_trans=<out\_trans>\r

**Parameters:**

Table 6-8 Exit the transparent transmission mode

| value       | meaning                                |
|-------------|--|
| Arbitrarily | Exit the transparent transmission mode |

## 6.2.13 remoteip

**Function:**

Remote ip or domain name setting

**Format:**

At+remoteip=< remoteip >\r

**Parameters:**

Remote server domain name or IP address

#### 6.2.14 remoteport

**Function:**

Remote port setting

**Format:**

At+ remoteport=<remoteport>\r

**Parameters:**

**Remoteport:** Remote port

#### 6.2.15 remotepro

**Function:**

Protocol Type setting

**Format:**

At+ remotepro=<remotepro>\r

**Parameters:**

Table 6-9 remotepro parameters setting

| value | meaning      |
|-------|--------------|
| None  | No protocol  |
| Tcp   | Tcp protocol |
| Udp   | Udp protocol |

#### 6.2.16 timeout

**Function**

Network time-out

**Format:**

At+timeout=<timeout>\r

**Parameters:**

Network time-out server

Network mode, when there is not any data transfer during the time-out, the connection will be disconnected. 0 specifies never disconnected.

#### 6.2.17 mode

**Function:**

The conversion mode setting

**Format:**

At+mode=<mode>\r

**Parameters:**

Table 6-10 mode setting

| value  | meaning      |
|--------|--------------|
| None   | No protocol  |
| Client | Tcp protocol |
| Server | Udp protocol |

## 6.2.18 uart

**Function:**

Serial configuration setting

**Format:**

At+uart=&lt;baud&gt;, &lt;data&gt;, &lt;parity&gt;, &lt;stop&gt;\r

**parameters:**

Baud: Baud rate

Data: Data bits

Parity: Parity bit

Stop: length of stop bit

## 6.2.19 uartpacklen

**Function:**

Serial framing length setting

**Format:**

At+uartpacklen =&lt;uartpacklen&gt;\r

**Parameters:****uartpacklen:** Serial framing length (Unit: bit) .Default value: 64.

## 6.2.20 uartpacktimeout

**Function:**

Serial framing time setting

**Format:**

At+ uartpacktimeout=&lt;uartpacktimeout&gt;\r

**Parameters:****uartpacktimeout:** Serial framing time (unit: ms)。Default value:10

## 6.2.21 escape

**Function:**

Serial exiting the Pass-through enable

**Format:**

At+ escape=<escape>\r

**Parameter:**

escape: 0 - close, 1 - enable

#### 6.2.22 tcp\_auto

**Function:**

TCP automatic reconnection

**Format:**

At+ tcp\_auto=<tcp\_auto>\r

**Parameter:**

tcp\_auto: 0 - close, 1 - enable.

#### 6.2.23 save

**Function:**

Submitted to serial converter configuration and restart the service.

**Format:**

At+ save=<save>\r

**Parameters:**

Table 6-11 submit to network setting

| value | meaning |
|-------|---------|
| 0     | invalid |
| 1     | submit  |

#### 6.2.24 reconn

**Function:**

Restart serial transformation service

**Format:**

At+ reconn =< reconn >\r

**Parameters:**

Table 6-12 reconn

| value       | meaning                               |
|-------------|---------------------------------------|
| arbitrarily | Restart serial transformation service |

## 6.2.25 ver

**Function:**

Inquiry the firmware version

**Format:**

At+ ver =? \r

**Parameters:**

None

## 6.3 AT command control code roution

## 6.3.1 Inquiry configuration information

## Code:

```
char *query="\n\nat+netmode=?\r\n\nat+wifi_conf=?\r\n\nat+dhcpcd=?\r\n\nat+dhcpcd_ip=?\r\n\nat+dhcpcd_dns=?\r\n\nat+dhcpcd_time=?\r\n\nat+dhcpc=?\r\n\nat+net_ip=?\r\n\nat+net_dns=?\r\n\nat+net_wanip=?\r\n\n\nat+remoteip=?\r\n\nat+remoteport=?\r\n\nat+remotepro=?\r\n\nat+timeout=?\r\n\nat+mode=?\r\n\nat+uart=?\r\n\nat+uartpacklen=?\r\n\nat+uartpacktimeout=?\r\n\nat+ver=?\r\n\n";
```

```
Com_send(query);
```

## Run,return:

```
at+netmode=? 0\nat+wifi_conf=? Hi-Link,wpa2_aes,12345678
```

```
at+dhcpd=? 0
at+dhcpd_ip=? 192.168.14.1,192.168.15.254,255.255.254.0,192.168.15.254
at+dhcpd_dns=? 192.168.15.254,0.0.0.0
at+dhcpd_time=? 86400
at+dhcpc=? 1
at+net_ip=? 192.168.15.254,255.255.254.0,192.168.11.1
at+net_dns=? 192.168.11.1,0.0.0.0
at+net_wanip=? ,,
at+remoteip=? 192.168.11.245
at+remoteport=? 8080
at+remotepro=? tcp
at+timeout=? 0
at+mode=? server
at+uart=? 115200,8,n,1
at+uartpacklen=? 64
at+uartpacktimeout=? 10
at+ver=? V1.39(Dec 6 2012)
```

### 6.3.2 Serial to Ethernet(Dynamic ip address)

Code:

```
char *commands_eth="\
|
at+netmode=1\r\n|
at+dhcpc=1\r\n|
|
at+remoteip=192.168.11.245\r\n|
at+remoteport=8080\r\n|
at+remotepro=tcp\r\n|
at+timeout=0\r\n|
at+mode=server\r\n|
at+uart=115200,8,n,1\r\n|
at+uartpacklen=64\r\n|
at+uartpacktimeout=10\r\n|
at+net_commit=1\r\n|
at+reconn=1\r\n|
";

Com_send(commands_eth);
```

Run and return:

```
at+netmode=1 ok
at+dhcpc=1
at+remoteip=192.168.11.245 ok
```

```
at+remoteport=8080 ok
at+remotepro=tcp
at+timeout=0 ok
at+mode=server
at+uart=115200,8,n,1 ok
at+uartpacklen=64 ok
at+uartpacktimeout=10 ok
at+net_commit=1
```

### 6.3.3 Serial to Ethernet(static ip address)

Code:

```
char *commands_eth_static="\
|
at+netmode=1\r\n|
at+dhcpc=0\r\n|
at+net_ip=192.168.11.254,255.255.255.0,192.168.11.1\r\n|
at+net_dns=192.168.11.1,8.8.8.8\r\n|
|
at+remoteip=192.168.11.245\r\n|
at+remoteport=8080\r\n|
at+remotepro=tcp\r\n|
at+timeout=0\r\n|
at+mode=server\r\n|
at+uart=115200,8,n,1\r\n|
at+uartpacklen=64\r\n|
at+uartpacktimeout=10\r\n|
at+net_commit=1\r\n|
at+reconn=1\r\n|
";
```

```
Com_send(commands_eth_static);
```

Run and return:

```
at+netmode=1 ok
at+dhcpc=0
at+net_ip=192.168.11.254,255.255.255.0,192.168.11.1 ok
at+net_dns=192.168.11.1,8.8.8.8 ok
at+remoteip=192.168.11.245 ok
at+remoteport=8080 ok
at+remotepro=tcp
at+timeout=0 ok
at+mode=server
at+uart=115200,8,n,1 ok
```

```
at+uartpacklen=64 ok
at+uartpacktimeout=10 ok
at+net_commit=1
```

### 6.3.4 Serial to wifi client(dynamic IP address)

Code:

```
char *commands_wifi_client="\
|
at+netmode=2\r\n|
at+wifi_conf=HI-LINK,wpa2_aes,12345678\r\n|
at+dhcpc=1\r\n|
|
at+remoteip=192.168.11.245\r\n|
at+remoteport=8080\r\n|
at+remotepro=tcp\r\n|
at+timeout=0\r\n|
at+mode=server\r\n|
at+uart=115200,8,n,1\r\n|
at+uartpacklen=64\r\n|
at+uartpacktimeout=10\r\n|
at+net_commit=1\r\n|
at+reconn=1\r\n|
";
```

```
Com_send(commands_wifi_client);
```

Run and return:

```
at+netmode=2 ok
at+wifi_conf=HI-LINK,wpa2_aes,12345678 ok
at+dhcpc=1
at+remoteip=192.168.11.245 ok
at+remoteport=8080 ok
at+remotepro=tcp
at+timeout=0 ok
at+mode=server
at+uart=115200,8,n,1 ok
at+uartpacklen=64 ok
at+uartpacktimeout=10 ok
at+net_commit=1
```

### 6.3.5 Serial to wifi client(static IP address)

Code:

```
char *commands_wifi_client_static="\
```



```
\
at+netmode=2\r\n\
at+wifi_conf=HI-LINK,wpa2_aes,12345678\r\n\
at+dhcpc=0\r\n\
at+net_ip=192.168.11.254,255.255.255.0,192.168.11.1\r\n\
at+net_dns=192.168.11.1,8.8.8.8\r\n\
\
at+remoteip=192.168.11.245\r\n\
at+remoteport=8080\r\n\
at+remotepro=tcp\r\n\
at+timeout=0\r\n\
at+mode=server\r\n\
at+uart=115200,8,n,1\r\n\
at+uartpacklen=64\r\n\
at+uartpacktimeout=10\r\n\
at+net_commit=1\r\n\
at+reconn=1\r\n\
";

Com_send(commands_wifi_client_static);
```

#### Run and return:

```
at+netmode=2 ok
at+wifi_conf=HI-LINK,wpa2_aes,12345678 ok
at+dhcpc=0
at+net_ip=192.168.11.254,255.255.255.0,192.168.11.1 ok
at+net_dns=192.168.11.1,8.8.8.8 ok
at+remoteip=192.168.11.245 ok
at+remoteport=8080 ok
at+remotepro=tcp
at+timeout=0 ok
at+mode=server
at+uart=115200,8,n,1 ok
at+uartpacklen=64 ok
at+uartpacktimeout=10 ok
at+net_commit=1
```

#### 6.3.6 Serial to wifi AP

##### Code:

```
char *commands_wifi_ap="\
\
at+netmode=3\r\n\
at+wifi_conf=Hi-Link_,wpa2_aes,0000000000\r\n\
```

```
at+dhcpcd=1\r\n|\n|
at+dhcpcd_ip=192.168.16.100,192.168.16.200,255.255.255.0,192.168.16.254\r\n|\n|
at+dhcpcd_dns=192.168.16.254,8.8.8.8\r\n|\n|
at+dhcpcd_time=86400\r\n|\n|
at+net_ip=192.168.16.254,255.255.255.0,192.168.16.254\r\n|\n|
at+net_dns=192.168.16.254,8.8.8.8\r\n|\n|
at+remoteip=192.168.11.245\r\n|\n|
at+remoteport=8080\r\n|\n|
at+remotepro=tcp\r\n|\n|
at+timeout=0\r\n|\n|
at+mode=server\r\n|\n|
at+uart=115200,8,n,1\r\n|\n|
at+uartpacklen=64\r\n|\n|
at+uartpacktimeout=10\r\n|\n|
at+net_commit=1\r\n|\n|
at+reconn=1\r\n|\n|
";
```

```
Com_send(commands_wifi_ap);
```

#### Run and return:

```
at+netmode=3 ok
at+wifi_conf=Hi-Link_wpa2_aes,0000000000 ok
at+dhcpcd=1 ok
at+dhcpcd_ip=192.168.16.100,192.168.16.200,255.255.255.0,192.168.16.254 ok
at+dhcpcd_dns=192.168.16.254,8.8.8.8 ok
at+dhcpcd_time=86400 ok
at+net_ip=192.168.16.254,255.255.255.0,192.168.16.254 ok
at+net_dns=192.168.16.254,8.8.8.8 ok
at+remoteip=192.168.11.245 ok
at+remoteport=8080 ok
at+remotepro=tcp
at+timeout=0 ok
at+mode=server
at+uart=115200,8,n,1 ok
at+uartpacklen=64 ok
at+uartpacktimeout=10 ok
at+net_commit=1
```

#### 6.3.7 Restore factory value

##### Code:

```
char *commands_device_default=""
```

```
\  
at+default=1\r\n\  
at+reboot=1\r\n\  
";
```

```
Com_send(commands_device_default);
```

Run and return:

```
at+default=1
```

After 30s, the modules start normally, all configuration parameters change to the factory configuration.

## 7 Serial configuration tools

HLK-RM04 CONFIG is a configuration tools that configurate the module through the serial port. Tool interface is as follows:

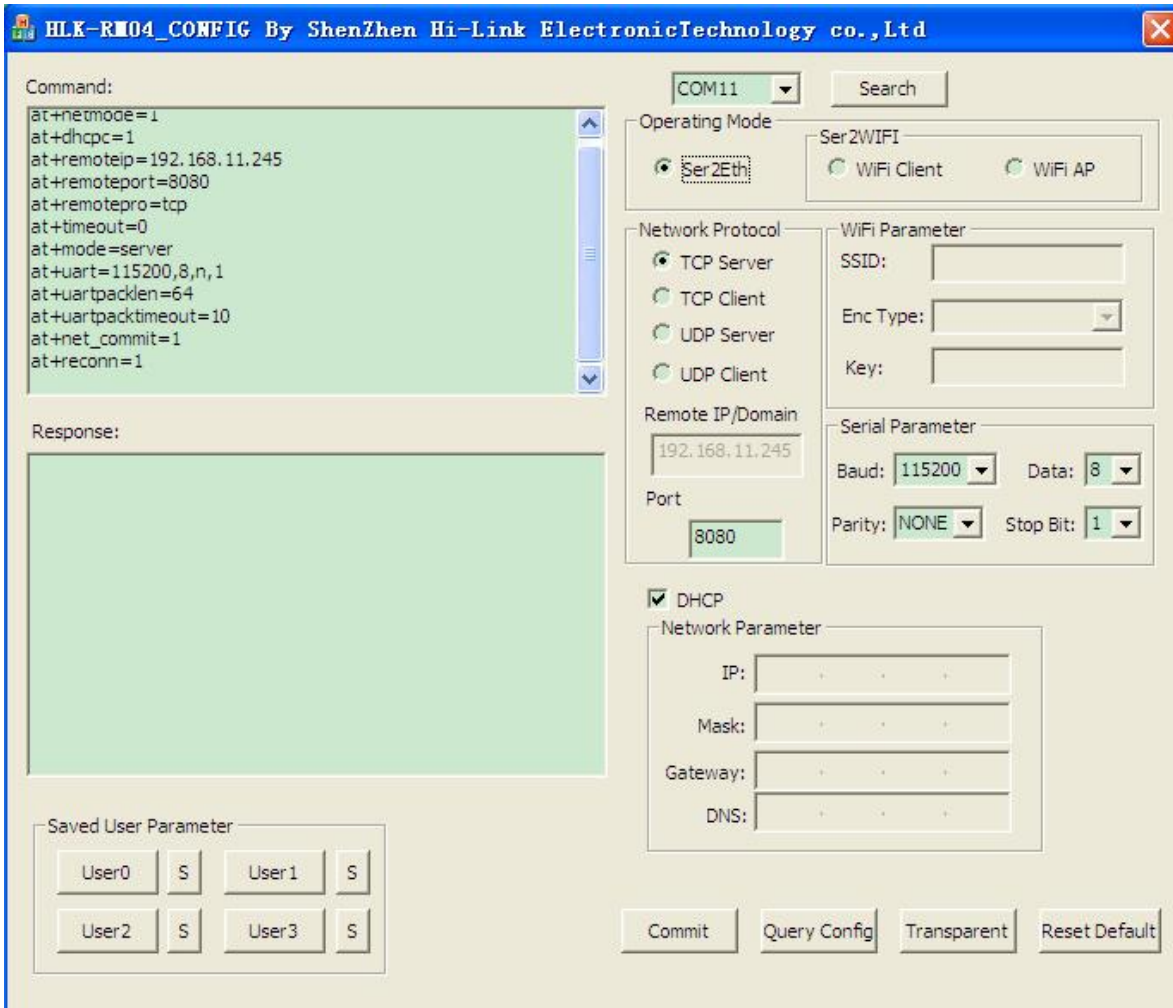

Chart 13 Configuration tools interface

**Description:**

1. 'Com 11' stands for configuration serial option
2. Search: module searching button
3. Operation mode: work mode selection
4. Wifi Parameter: wireless parameter configuration
5. Network Protocol: Network protocol selection
6. Serial Parameter: Serial parameter configuration
7. IP: Network IP address configuration
8. Commit: submit the configuration
9. Query config: Inquiry the configuration
10. Transparent: Access to transparent transmission mode
11. Reset Default: Restore the factory value setting
12. Saved User Parameter: User parameter holding area
13. Command: Ready for sent AT instruction area

#### 14. Response: AT instruction return information area

##### 7.1 Searching the Module

Through the "configure serial port choice" choose PC serial number and click on the "search module" button, the tool will use the specified serial search the module HLK - RM04, the module will be searched if it has been connected and in AT instruction mode . The module information will be found in the AT instruction return information area. Shown as below:

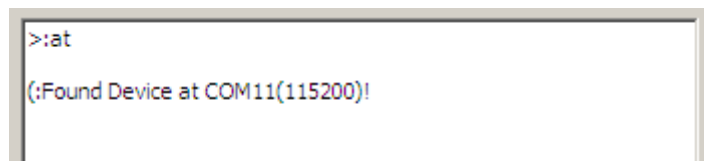

```
>:at
(:Found Device at COM11(115200)!
```

Chart 16 searching the module

At this time, The PC and module have been able to establish the normal AT command communication. All the AT interactive orders need to process based on the normal AT instruction communication.

##### 7.2 Set each Parameters

Configure the required function through the configuration items 3, 4, 5, 6, 7. The Configuration and modification information would immediately create the matching AT command in the ready for sent AT instruction area. The generated AT instruction will not send to the module at once. Shown as below:

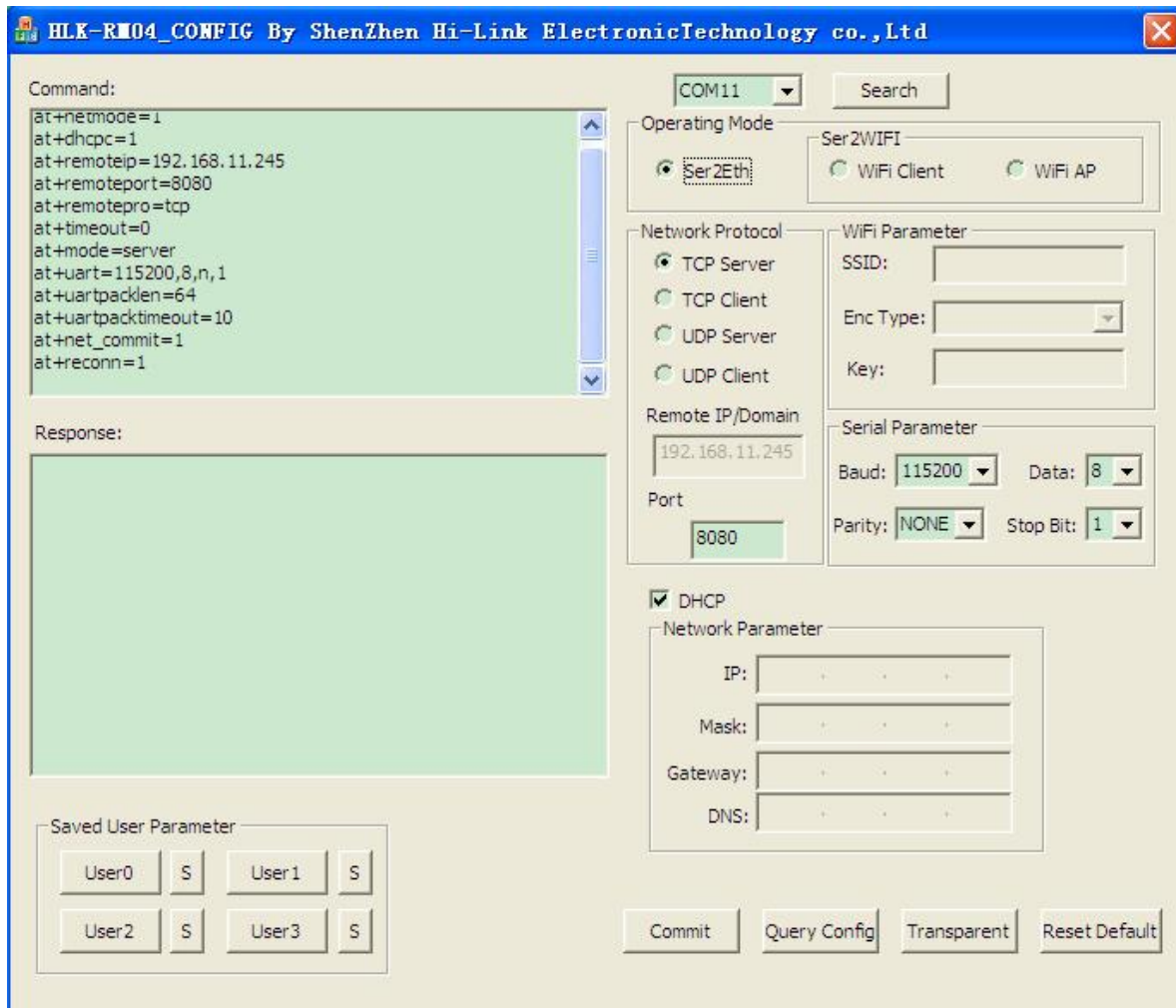

Chart 17 Serial configuration tool generates AT command

### 7.3 Submit the configuration

Click the submit configuration button, the tool will send the AT instruction in the ready for sent area to the module immediately. The information of command execution results will be shown in AT instruction return information area.



## Chart18. Serial configuration tools instruction execution

## 7.4 User Data Retention

The user parameter holding area provides parameter saving function. Through this function you can save up four sets of parameters at most, respectively, user0 user1, user2, user3. Click "S" button, it will pop up a confirmation dialog shown as below:



Chart 19. Pop-up Dialog of parameter saving

Click on the button "yes", the instruction in the ready for sent AT instruction area will save for user0 parameter group. After this step, when you click "user0" anytime, this parameter group can be called immediately, and covered to the ready for sent AT instruction area.

The stored user parameter will save as text file in the tools contents, file name, respectively, user0, user1, user2, user3.

## 7.5 Inquiry configuration

Click on the button 'inquiry', The tool will send a series of AT instructions immediately to the module to inquire the current configuration of the module, the result of execution will show in AT instruction return information area at once, each configuration items will make corresponding change with the return information.

## 7.6 Access to transparent transmission mode

If the module has already in the AT instruction mode, click on the button 'T/T', you can access to the transparent transmission mode at once.

## 7.7 Restore factory factory value setting

Click on the button 'reset', the tool will pop up a confirmed box shown as below:

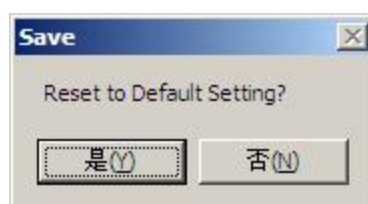

### Chart 20 Pop-up box for reset default setting

Click on the button 'yes', The tools will send AT instruction immediately, after about 30 seconds, the module will access to the default state.

### 8 Device Search tools

HLK-RM04\_Discover is a search tool of network end used to search the module HLK-RM04. The interface is as follows:

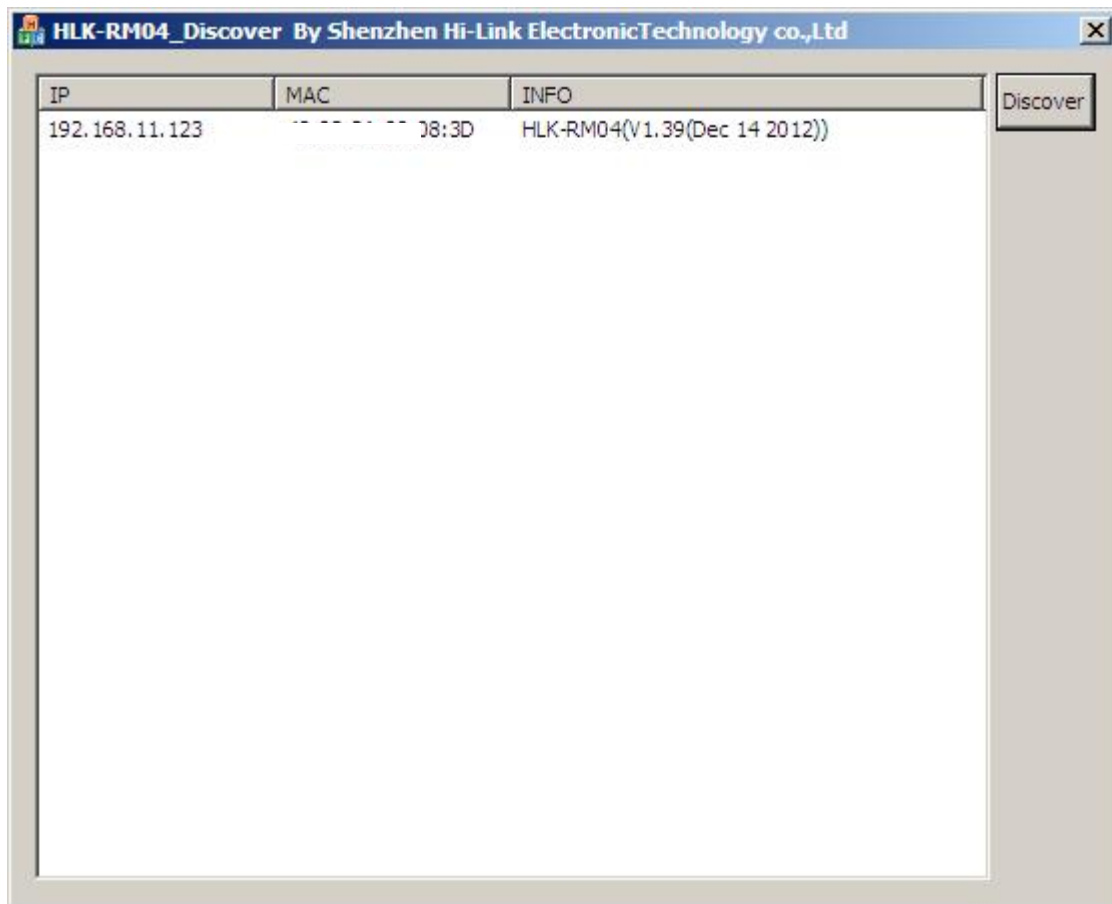

Chart 21. Device search tools

Click on the button "Discover", the tools will search all the HLK-RM04 module connected with PC in the LAN. The module being searched will show in the information box soon. The module information including: IP address, MAC address and version of it.



## 9 Restore factory Settings

Support the following ways to restore the factory settings

1. Through the Web page.
- 2 By keeping the ES/RST pin low level time greater than Trst.

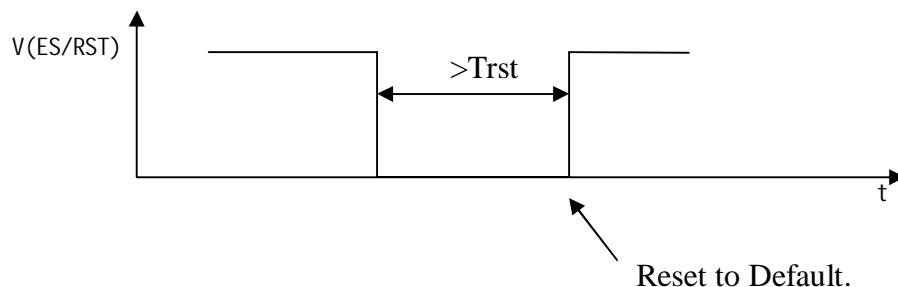

Factory setting parameter values see the following list:

|                              |  |
|------------------------------|--|
| <b>netmode</b>               | 0  |
| <b>wifi_conf</b>             | Hi-Link_,wpa2_aes,12345678                               |
| <b>dhcpc</b>                 | 1  |
| <b>net_ip</b>                | 192.168.11.254,255.255.255.0,192.168.11.1                |
| <b>net_dns</b>               | 192.168.11.1,8.8.8.8                                     |
| <b>dhcpcd</b>                | 1  |
| <b>dhcpcd_ip</b>             | 192.168.16.100,192.168.16.200,255.255.255.0,192.168.16.1 |
| <b>dhcpcd_dns</b>            | 192.168.16.1,8.8.8.8                                     |
| <b>dhcpcd_time</b>           | 86400  |
| <b>remoteip</b>              | 192.168.11.245   |
| <b>remoteport</b>            | 8080   |
| <b>remotepro</b>             | tcp  |
| <b>timeout</b>               | 0  |
| <b>mode</b>                  | none   |
| <b>uart</b>                  | 115200,8,n,1   |
| <b>uartpacklen</b>           | 64   |
| <b>uartpacktimeout</b>       | 10   |
| <b>IP address</b>            | 192.168.16.254   |
| <b>Wifi password</b>         | 12345678   |
| <b>Web username/password</b> | admin/admin  |

|      |       |
|------|-------|
| Tes  | 100ms |
| Trst | 6s    |

## 10 Firmware upgrade

1. Restore the factory value.
2. Pc can connect with module through Ethernet, ip: 192.168.16.123/255.255.255.0. Browser visits 192.168.16.254. Username / password: admin / admin.
3. Open the following page. Select the appropriate firmware, click apply upgrades. Wait about 3 minutes. Can not cut out the upgrade process, otherwise it may cause damage to the module.



## Appendix A document revision record

| Version number | Revision range | Date       |
|----------------|----------------|------------|
| 1.00           | Draft version  | 2012-9-10  |
| 1.10           |                | 2012-12-1  |
| 1.20           | Firmware v1.41 | 2013-01-14 |